Pro Pump Controller (PROCON-100)



Operation Manual

Contents

1	Safety Precautions	5
2	General Information	9
2.1	General Information	9
2.2	Warranty	9
2.3	Technical Support	9
2.4	Precautions	10
3	Features of Pro Pump Controller (ProCon-100)	11
3.1	Feature of ProCon-100	11
3.2	Appearance and Specifications of ProCon-100	12
3.2.1	Appearance of ProCon-100	12
3.2.2	Specification of ProCon-100	13
4	Name of each part of the Controller (ProCon-100)	14
4.1	ProCon-100 Detailed Description	14
4.2	Time Chart	20
4.2.1	Time Mode	20
4.2.2	Steady Mode	21
5	Functions of Pro Pump Controller (ProCon-100)	22
5.1	Mode Description	22
5.1.1	Time Mode	22
5.1.2	Steady Mode	23
5.1.3	Metering Mode	24
5.2	Setting Button	25
5.3	Time Mode Setting	27
5.3.1	Shot Time Setting	28
5.3.2	Shot Speed Setting	29
5.3.3	Suck Back Time Setting	29

5.3.4	Suck Back Speed Setting.....	30
5.3.5	Compensation Setting	31
5.4	Steady Mode Setting.....	32
5.4.1	Shot Speed Setting	33
5.4.2	Suck Back Time Setting.....	34
5.4.3	Suck Back Speed Setting.....	35
5.4.4	Compensation Setting	36
5.5	Metering Mode Setting.....	37
5.5.1	Volume Setting	38
5.5.2	Shot Speed Setting	39
5.5.3	Suck Back Time Setting.....	40
5.5.4	Suck Back Speed Setting.....	41
5.5.5	Compensation Setting	42
5.5.6	Purge Time Setting	43
5.6	System Set.....	44
5.6.1	Calibration	45
5.6.2	Pressure Set	47
5.6.3	System I/O Check	49
5.6.4	Parameter Setting.....	50
5.7	Lock Function Setting	51
5.7.1	Check Point before set-up the Lock Function	51
5.7.2	How to set-up the lock function	52
5.7.3	How to operate during locking.....	53
5.7.4	How to Unlock	54
5.8	Pressure sensor for PROCON-100 (option).....	56
5.8.1	Connection guide	56
5.8.2	How to set up the pressure sensor function on controller	57
5.8.3	I/O communication for pressure transducer.....	59

6	Controller Internal Configuration	60
7	Maintenance	61
7.1	Part Replacement	61
7.2	Trouble Shooting.....	62
7.3	Inspection and Measures	63

1 Safety Precautions

This manual is applied to products manufactured and sold by Taeha Corp. (here in after referred to as "our company") and, therefore must not be used in partial or full copy without permission of our company.

This manual explains the specifications, installation, wiring, maintenance check, abnormal phenomena and measures to be taken for our products. When using this product, please read this manual carefully, pay enough attention to safety and handle it properly.

The safety precautions have been classified into "Danger" and "Caution".



"Danger" means that dangerous situations can occur and death or serious injury could result, if handled incorrectly.



"Caution" means that dangerous situations can occur if handled incorrectly. Also you may get serious injury or physical damage.

In addition, even if it is indicated as caution, it may lead to serious consequences depending on the situation. Since this is important for the safety of the user, please make sure you follow the instructions.

Precautions against electric shock



Danger
<ol style="list-style-type: none"> 1. This equipment is kept under high pressure for a while even after the main power supply is cut off. When performing a wiring work or inspection that touches all terminals of the terminal block, leave it for at least five minutes after shutting off the power before you start the work. 2. To prevent electric shock and malfunction, please provide class 3 grounding (100Ω or less, wire diameter 1.6mm or thicker). 3. Inspection and maintenance of this equipment must be performed by a qualified technician(specialist). 4. Do not inspect equipment with wet hands, when the floor is wet or if there is too much moisture. It may cause electric shock. 5. Be careful not to damage the cable, place heavy objects on it or fold it. In case it is damaged, it may cause electric shock.

Precautions against fire



Danger
<ol style="list-style-type: none"> 1. Do not install this equipment near inflammables, combustible organic solvents or vapors. The heat and electrical operation can cause fire. 2. If this equipment malfunctions, disconnect the main power supply of the equipment. The high current may cause a fire.

Precautions of wiring



Danger
<ol style="list-style-type: none"> 1. Before conducting wiring work for maintenance etc., be sure to shut off all the external power supplies used by the equipment. Failure to do so may result in electric shock or damage to the equipment. 2. To supply power or operate the equipment after wiring, be sure to attach the covers inside and outside the equipment. Failure to do so may result in injury and electric shock.
Caution
<ol style="list-style-type: none"> 1. Do not apply main power supply except for that of the voltage specified in this user manual. It may cause malfunction.



2. Make sure that terminal connections and wiring are correct. It may cause malfunction.
3. While the electric current is being applied, do not change the wiring or detach the connector. It may cause injury or equipment failure.
4. If the power wiring in the driving area is wrong, it may cause injury or damage to the equipment due to malfunction. Be careful.

Precautions on installation



Caution

1. Do not install, store and use in places exposed to conductive dust, corrosive gas, flammable gas, high temperature, condensation, wind and rain, etc.
2. Exposure to direct sunlight for a long time will degrade accuracy of the equipment. Do not install, store or use in areas where there is direct sunlight.
3. When installing in an enclosed space, install a separate cooling fan to allow the outside air to flow in and out, in order to maintain the temperature around the equipment at 40°C or less. Overheating may cause fire or other accidents.

Precautions on use



Caution

1. Never modify this equipment. It may cause electric shock, injury, fire or breakdown.
2. Once you modify this equipment, it cannot be covered by our warranty for defects.
3. Before use, be sure to check that all covers are properly installed and verify if there is no foreign material inside the equipment. Depending on the circumstances, unexpected operation can occur and may result in injury.
4. If an alarm occurs during use, remove the cause of the alarm, check the safety, and reuse it.

Danger



1. When the equipment of our company is used including robots (multi-joint robot, rectangular coordinate robot, desktop robot), please be sure to install a safety net in the robot operation area, and never approach the operation area during operation.

2. Equipment of our company include driving and rotating parts. Install a safety net on the rotating parts and never approach it during operation.

Precautions for maintenance and inspection



Caution

1. When cleaning or repairing the equipment, be sure to turn off the power and check the internal power supply for complete discharging, and then have it carried out by a qualified maintenance specialist. Maintenance by non-experts can cause breakdown.
2. If there is a breakdown of the equipment, do not disassemble the equipment. Please contact our customer support team.
3. If dust accumulates on the equipment, it may cause malfunction. Clean up the equipment periodically. When cleaning, please shut off the external power completely and check whether the equipment has been fully discharged. There is a danger of electric shock.

Precautions for disposal



Caution

1. When this equipment is disposed of, treat it as industrial waste.

2 General Information

2.1 General Information

This user manual provides the user and the equipment maintenance specialist with essential information for operating the equipment. Therefore, it is strongly recommended that you should thoroughly understand this user manual.

In order to have easy access to this user manual, it must be placed where it can be easily seen, near the equipment.

2.2 Warranty

Except for a separate agreement and the following cases, the warranty period will be one year in the event of defects.

- Following -

1. In case you modify the equipment without permission by Taeha Corp.
2. If someone other than the technical support personnel of Taeha Corp. modifies the equipment or repairs the equipment without using the designated parts.
3. If any spare parts other than those specified by Taeha Corp. have been used for the product.
4. In case of intentional damage or damage due to consumer's fault
5. In case of natural disasters or fire

2.3 Technical Support

If necessary, Taeha Corp. will provide technical support service for the customer. Please contact us by phone or fax.

Contact

Phone : +82(0)31 552 5300

Fax : +82(0)31 552 5400

Email : taeha@taehacorp.com

www.taehacorp.com

2.4 Precautions



Danger

- Be sure to use the designated power supply. The basic power of the equipment is designated as AC220V 50/60Hz.
- Be sure to use the designated air pressure. The basic air pressure of the equipment is designated as 5kgf/cm².
- Do not operate with wet hands. There is a risk of electric shock.
- During the operation, do not turn off the power or shut down the air pressure unless the equipment is in danger/caution. Serious problems may arise with the use of equipment.
- Contact us in case of severe errors in the equipment.

3 Features of Pro Pump Controller (ProCon-100)

3.1 Feature of ProCon-100

This is equipment that applies resin using desktop robot and dispenser controller, and it is the equipment which can adjust the application position and application volume.

- ◆ One-component dispensing – Ideal for fixed volume dispensing during a long period of time.
 - ✓ With installing of one-component dispenser exclusive software, precise and various works can be done.
 - ✓ With color touch screen, it has good data recognition and it is easy to operate
 - ✓ Convenient due to the memory function(16ch). Highly compatible with other equipment such as PC and PLC.
 - ✓ External interface function enables various tasks to be performed continuously.
 - ✓ Setting and changing of data are intuitive and easy to operate

- ◆ Major application examples
 - ✓ Various sensors
 - ✓ Solar cell panels
 - ✓ Epoxy dispensing on auto parts
 - ✓ Application of urethane to various filters

3.2 Appearance and Specifications of ProCon-100

3.2.1 Appearance of ProCon-100

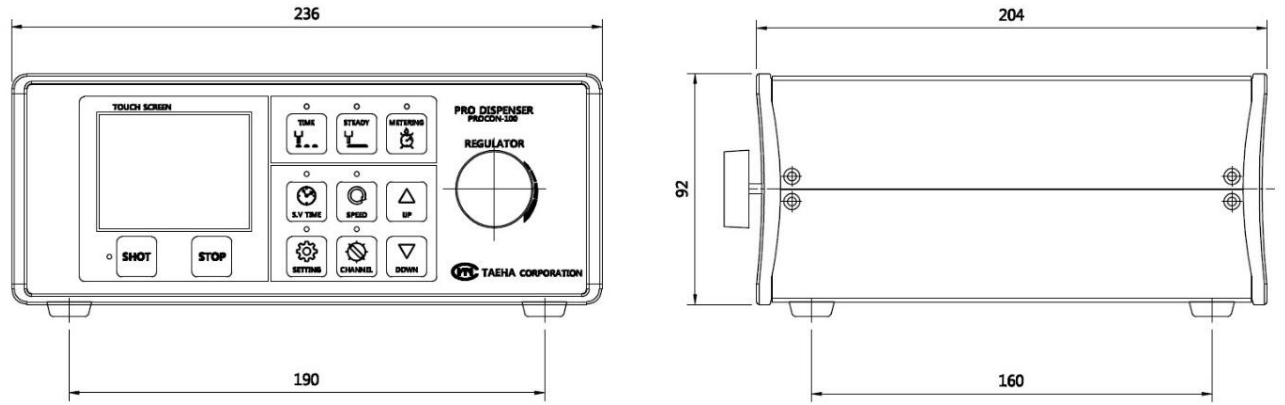

Figure 1. Appearance of Procon-100

3.2.2 Specification of ProCon-100

Table 1. Specification of Procons-100

Category	Specification	Remarks
Name	ProCon-100	
Size(H x W x D)	236mm x 92mm x 204mm	
Input Power	AC 220V 50/60Hz(1Phase)	±10%
Power Consumption	Max. 50W	
Display	2.8inch TFT LCD	Touch Type
Operation	Touch Panel, Button, Rotary Knob	
Operation Mode	Time, Steady, Interval	3 Mode
Operation Memory	15ch	User Define
Operating air pressure	5kgf/cm ² (humidity 5% orles)	Air Filter : 5μ
Pressure Regultion	0 ~ 5kgf/cm ²	
Air In Port	One Touch Fitting PC(φ6, Max.7kgf/cm ²)	Air Hose
Air Out Port	Auto Jinter (PH-H4)	
Liquid Indicator Sensor	OK	
External Control	OK	
Input Signal	Contact Input or NPN Open Collector	
Dosing End Signal	NPN Open Collector	
Dosing Connector	21004525-05	21004221-02
Motor Connector	21008525-02	21008223-01-001
Comm. Connector	DSUB 9Pin	RS-232(Maker Use)
Sensor Connector		Contact us
Input/Output Connector	STL950/12-5.0-V-GREEN	AK950/12-5.0-GREEN
Weight	1.8kgf	
Operating Temperature	5 ~ 40°C	Avoid direct sunlight
Operating Humidity	10 ~ 85%RH(without condensation)	
Vibration Resistant	0.5g or less	g:gravity acceleration

4 Name of each part of the Controller (ProCon-100)

4.1 ProCon-100 Detailed Description

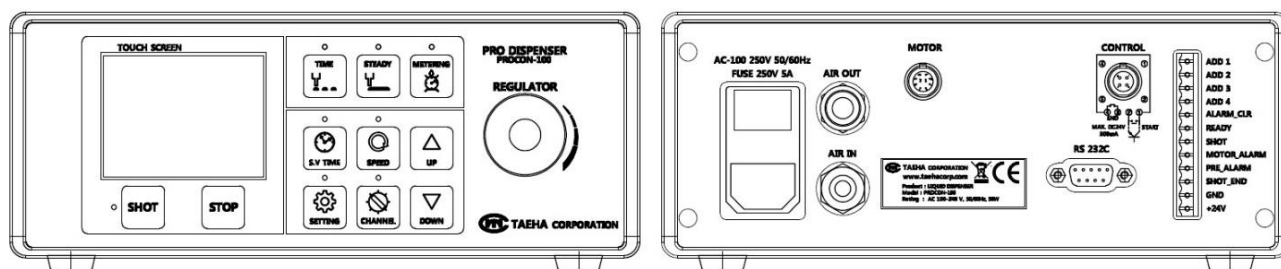
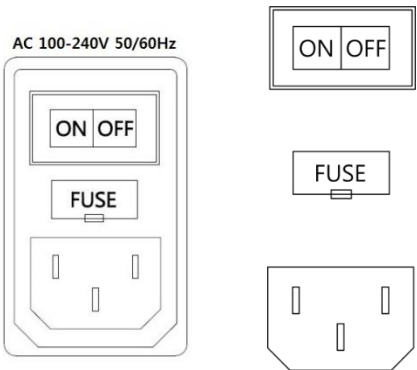

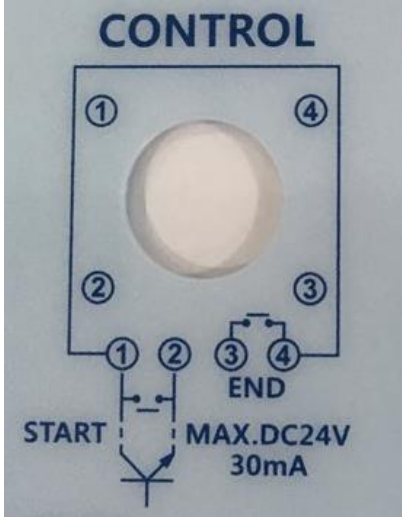
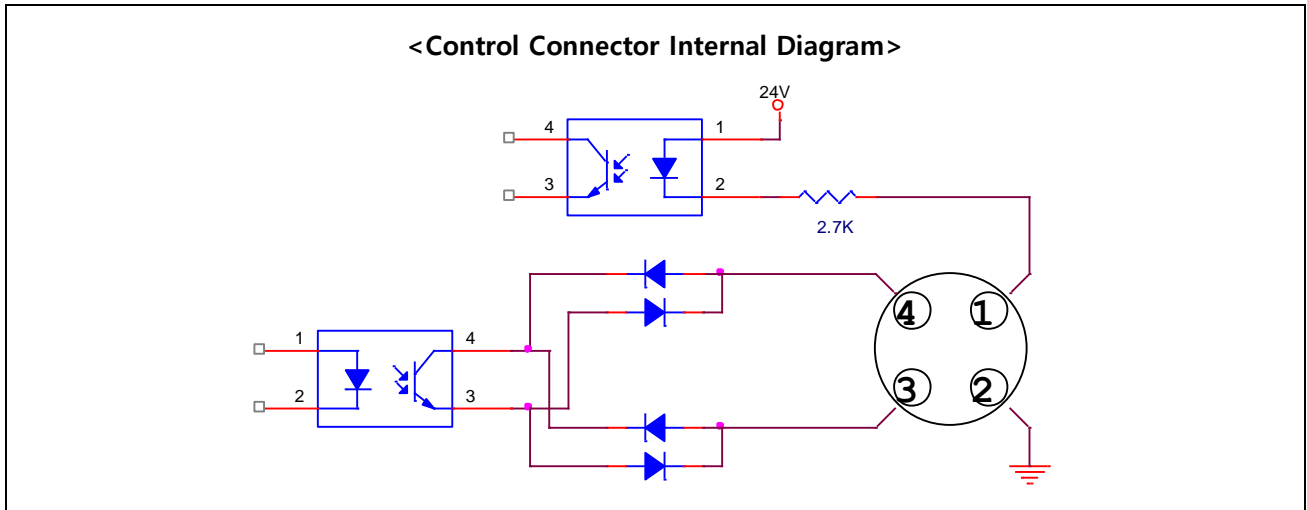

Figure 2. Front / Rear of Procon-100

Table 2. Name of each part of the Procon-100

Names and Displays	Function and Description
<p style="text-align: center;"><Touch Screen></p>	<ul style="list-style-type: none"> * For one-component fixed volume dispensing, you can set/check mode selection, dispensing condition setting, mixing ratio setting, dis.
<p style="text-align: center;"><Regulator(Pressure control)></p> <p style="text-align: center;">Regulator</p>	<ul style="list-style-type: none"> * Supplies the pressure to the Pro-Pump in order to replenish materials smoothly. * Self-leveling pressure may not be required for low viscosity.

<p style="text-align: center;"><Combination Switch></p> 	<ul style="list-style-type: none"> * Power Switch : Controller power ON/OFF function * Fuse Holder : Small glass tube 3A (include spare 1ea) * AC Receptacle : Power Cord inlet AC 100~240V, 50/60Hz Free Voltage * Be sure to provide grounding.
<p style="text-align: center;"><Air In Port></p> 	<ul style="list-style-type: none"> * Air in port for $\varnothing 6$ Air Hose. * Supply clean air filtered through a 5μm air filter, with moisture removed. (humidity 5% or less)
<p style="text-align: center;"><Air Out Port></p> 	<ul style="list-style-type: none"> * Release the regulator's regulated pressure. * Connect the supplied auto-jointer to the air out.
<p style="text-align: center;"><Control Connector></p> 	<ul style="list-style-type: none"> * This is connection port between the shot input signal and the shot end signal. * It uses circle 4 pin connector and outputs the dispensing signal input and dispensing completion signal from the outside. * When controlling dispensing operation from the higher controller to the output junction, make sure to connect GND and N24(COM) are connected between the higher controller and the controller. * When the dispensing is complete, the operational completion signal is output at approximately 30msec on purge. The complete operation signal is output only in time mode.



<Connection configuration of Host controller and Controller>

Procon-100

PLC

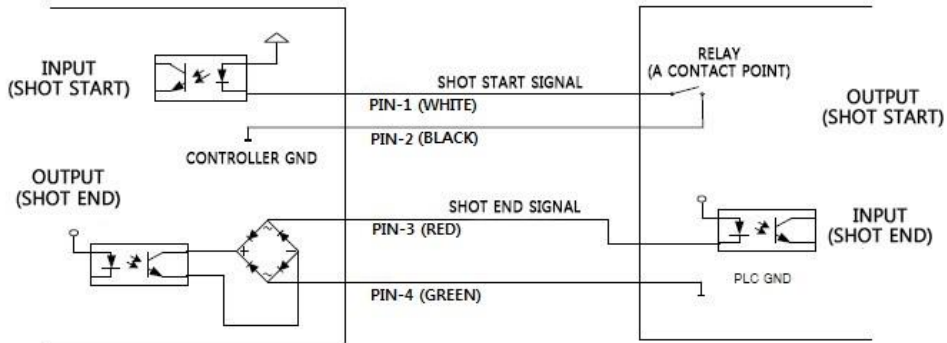

Wiring Method 1

-> As shown above, if you control the motion start signal from the PLC to the relay contacts, you do not need to COMMON the GND between the PLC and the controller.

Procon-100

PLC

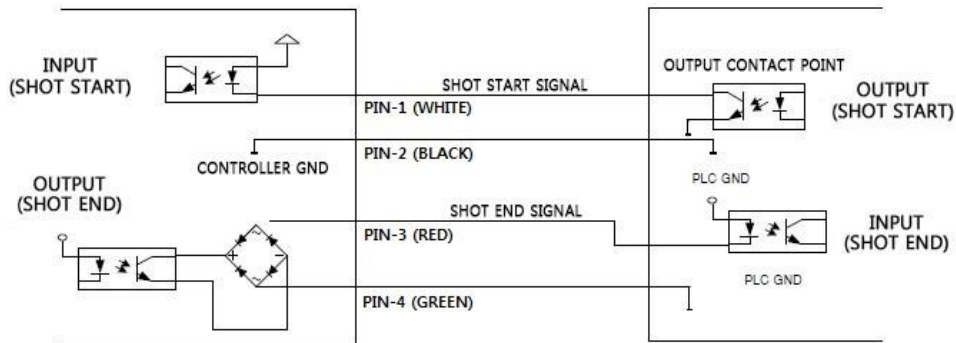

Wiring Method 2

-> If you control the operation start signal from the PLC to the output contact as shown above, you will need to COMMON the GND between the PLC and the controller.

The output of PROCON-100 is an open collector signal.

<RS 232C>

RS 232C

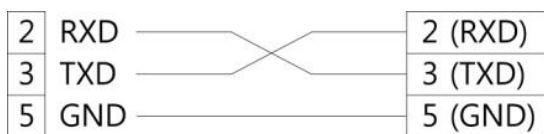
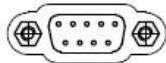

* D_SUB 9pin connector, used as controller firmware upgrade and debugging mode. (Users do not use it.)

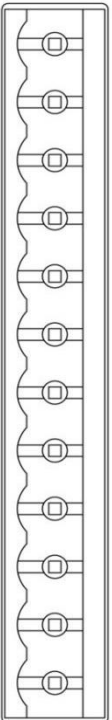
<p style="text-align: center;"><Control I/O Port></p>  <ul style="list-style-type: none"> - ADD1 - ADD2 - ADD3 - ADD4 - ALARM_CLR - READY - SHOT - MOTOR_ALARM - PRE_ALARM - SHOT_END - GND - +24V 	<ol style="list-style-type: none"> 1. ADD1 ~ ADD4 : Channel selection port, which allows you to change the channel from an external device and to dispense with preset dispensing conditions. It is composed of 16 channels. When changing channels, it is required to give a delay time of about 10msec or more. 2. ALARM_CLR : When an alarm occurs, remove it from the higher controller. (If the cause of the alarm is unknown, it will occur continuously.) 3. READY : Outputs a signal when there is no error in the controller and no shot is being performed. When controlled by the parent controller, monitor the ready signal to output the shot signal if it is on. 4. SHOT : Inform the shot status of the dispenser. "ON(High)" in active, "OFF (Low)" when stationary. 5. MOTOR_ALARM : On if the motor error. 6. PRE_ALARM:On if pressure setting is abnormal 7. SHOT_END : When the dispensing is complete, the operational completion signal is output at approximately 30msec on purge. The complete operation signal is output only in time mode. 8. GND : COMMON to match the DC power potential difference between the host controller and Procon-100. 9. +24V : Use this when the use of internal power supply of the controllers is necessary. <p>* Note : +24V is the power output. When external power is connected, failure occurs. (Abnormal operation)</p>
---------------------------------------------------------------------------------------------------------------------------------------------------------------------------------------------------------------------------------------------------------------------------------------------------------------------------------------------------------------------------------------------------------------------	----------------------------------------------------------------------------------------------------------------------------------------------------------------------------------------------------------------------------------------------------------------------------------------------------------------------------------------------------------------------------------------------------------------------------------------------------------------------------------------------------------------------------------------------------------------------------------------------------------------------------------------------------------------------------------------------------------------------------------------------------------------------------------------------------------------------------------------------------------------------------------------------------------------------------------------------------------------------------------------------------------------------------------------------------------------------------------------------------------------------------------------------------------------------------------------------------------------------------------------------------------------------------------------------------------------------------------------------------------------------------------------------------------------------------------------------------------------------------------------------------------------------------------------------------------

PROCON-100 I/O ERROR LIST

MOTOR_ALARM	Active Low	1. Motor Cable	It occurs when the motor cable is disconnected or in the case of faulty encoders.
		2. Motor Error	It occurs when the motor is overloaded.

PRE_ALARM	Active Low	3. Pressure Error	Applies when a pressure sensor is used. It occurs if the pressure rises above the set pressure.
-----------	------------	-------------------	-------------------------------------------------------------------------------------------------

Channel	ADD4	ADD3	ADD2	ADD1
**	OFF	OFF	OFF	OFF
If there is no ADD1~4 input at the terminals, the existing selected channel will be selected.				
1	OFF	OFF	OFF	ON
2	OFF	OFF	ON	OFF
3	OFF	OFF	ON	ON
4	OFF	ON	OFF	OFF
5	OFF	ON	OFF	ON
6	OFF	ON	ON	OFF
7	OFF	ON	ON	ON
8	ON	OFF	OFF	OFF
9	ON	OFF	OFF	ON
10	ON	OFF	ON	OFF
11	ON	OFF	ON	ON
12	ON	ON	OFF	OFF
13	ON	ON	OFF	ON
14	ON	ON	ON	OFF
15	ON	ON	ON	ON

4.2 Time Chart

Table 3. Procon-100 Time Chart

t1	Shot Key Check Time (10ms)
t2	Shot Time
t3	End Time (30ms)

4.2.1 Time Mode

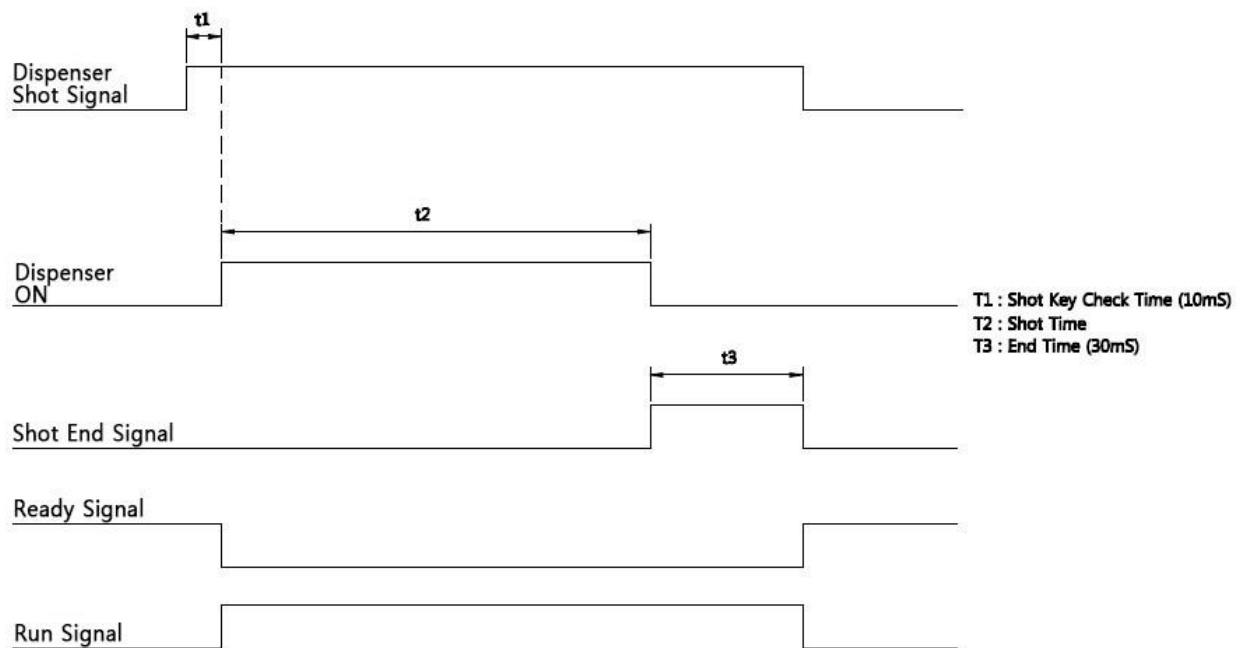

Figure 3.

4.2.2 Steady Mode

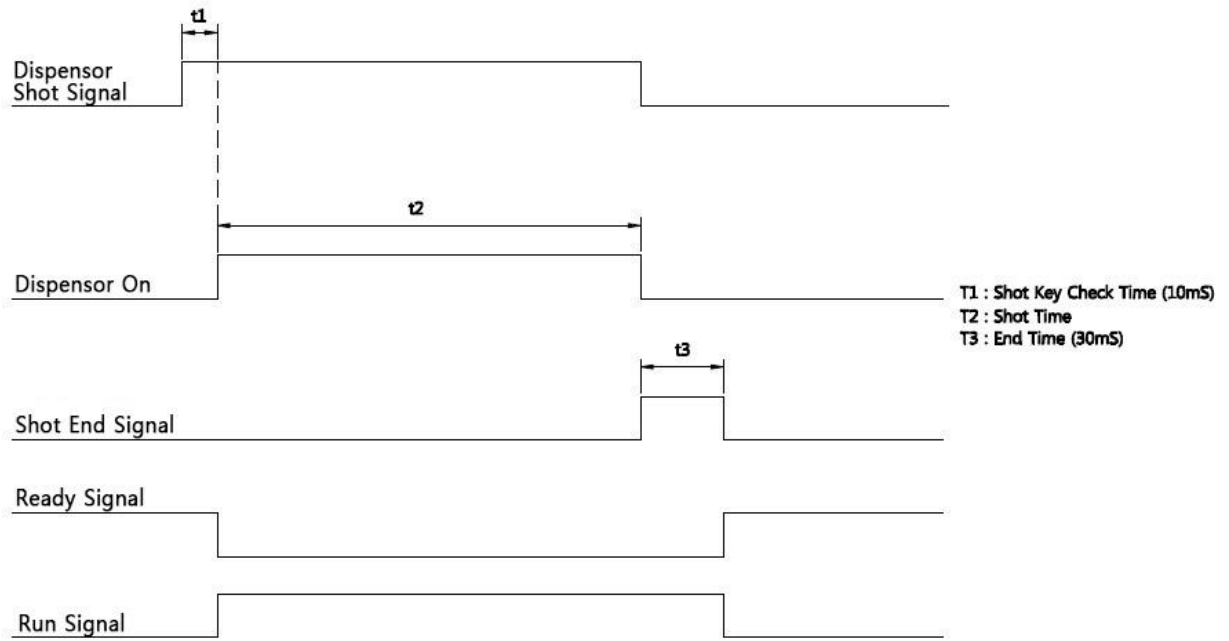

Figure 4. Steady Mode

5 Functions of Pro Pump Controller (ProCon-100)

5.1 Mode Description

5.1.1 Time Mode

The time mode is used to dispense at the set shot rate for a certain period of time. At it is dispensed at a certain shot rate for a certain period of time, it is often used in potting. Repeated dispensing is available for a certain period of time, it's advantageous for repeated quantitative dispensing.

TIME		NO.01
Shot_Time	:	1.20 sec
Shot Speed	:	50.0 rpm
Suck Time	:	0.00 sec
Suck Speed	:	50.0 rpm
Compensation	:	100 %
Pressure	:	0 kPa

Figure 5. Time Mode Main Screen

Table 4. Time mode screen detailed description

Screen	Function and Description
TIME NO.01	<ul style="list-style-type: none"> * Time : Displays the mode set * No.01 : Displays the channel
Shot_Time : 1.20 sec Shot Speed : 50.0 rpm	<ul style="list-style-type: none"> * Shot_Time : Displays the shot time. (Max. 9999.99sec) * Shot Speed : Display the pump speed at dispensing. (Max. 120 rpm)
Suck Time : 0.00 sec Suck Speed : 50.0 rpm	<ul style="list-style-type: none"> * Suck Time : Displays the sucking time. (0sec : Not operating) * Suck Speed : Displays the pump speed while sucking. (0~120rpm)
Compensation : 100 % Pressure : 0 kPa	<ul style="list-style-type: none"> * Compensation: The correction rate for the motor speed. If you adjust it randomly, the output will change. * Pressure : Displays the working pressure.

5.1.2 Steady Mode

Steady mode is used to dispense continuously at the set shot rate.

This mode is used when an external signal dispenses a certain amount in a certain section, it is often used in line dispensing.

The total volume dispensed by operation by external signal(PLC or the user’s operation) may change depending.



Figure 6. Steady Mode Main Screen

Table 5. Steady mode detailed description

Screen	Function and Description
	<ul style="list-style-type: none"> * Displays the set mode/channel.
	<ul style="list-style-type: none"> * Shot_Time : Display the dispensing time. (Max. 9999.99sec) * Shot Speed : Display the pump speed while dispensing.(0~120 rpm)
	<ul style="list-style-type: none"> * Suck Time : Display the sucking time. (0sec : Not Operating) * Suck Speed : Display the pump speed while sucking. (0~120rpm)
	<ul style="list-style-type: none"> * Compensation: The correction rate for the motor speed. If you adjust it randomly, the output will change. * Pressure : Display the working pressure.

5.1.3 Metering Mode

Metering mode is used if a precision dispensing is required.



Figure 7. Metering Mode Main Screen

Table 6. Metering mode detailed description

Screen	Function and Description
METERING NO.01	* Display the set mode/channel.
Volume : 15.0 mg Shot Speed : 50.0 rpm	* Volume : Display the amount of setting dispensed. * Shot Speed : Display the pump speed while dispensing.(0~120 rpm)
Suck Time : 0.00 sec Suck Speed : 50.0 rpm	* Suck Time : Display the sucking time. (0 sec : Not Operating) * Suck Speed : Display the pump speed shile sucking. (0~120 rpm)
Compensation : 100 % Pressure : 0 kPa	* Compensation: The correction rate for the motor speed. If you adjust it randomly, the output will change. * Pressure : Display the working pressure.

5.2 Setting Button

Procon-100 has a total of 9 setup buttons(4~12) at the front.

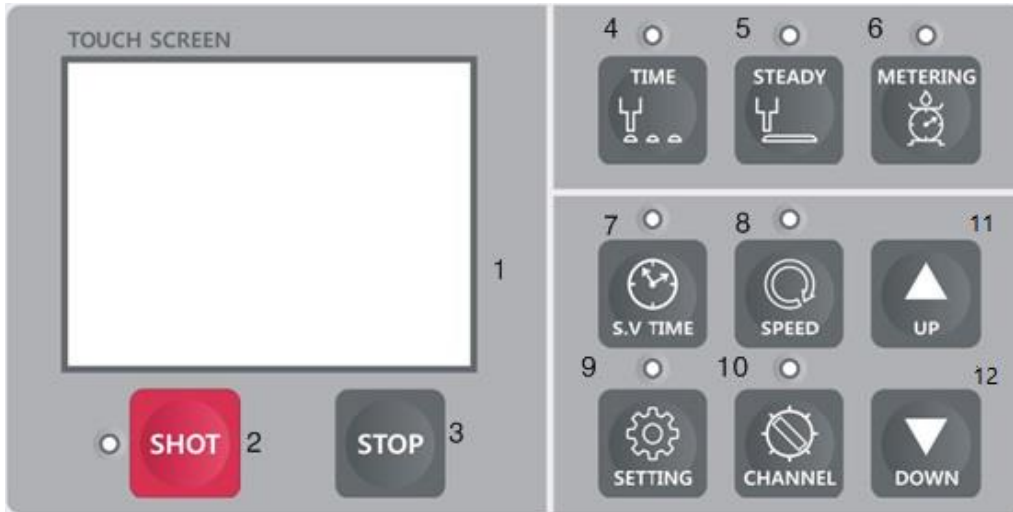











Figure 8. Procon-100 Touch Panel & Setup Buttons

Table 7. Function of the Controller Setup Button

Category	NO.	Item	Function
Mode Setting	4		It is the time mode button, which changes the time mode when pressed.
	5		It is the steady mode button, which changes the steady mode when pressed.
	6		It is the metering mode button, which changes the metering mode when pressed.
Select a Change	7		S.V Time(Set Value, Time) button can be selected in the time mode and the metering mode. When you press this button, the green LED on the button is lit. The time or volume can be changed using the up/down buttons. Press button again to cancel settings.
	8		Speed buttons are selectable for all modes. When you press this button, the green LED on the button is lit and the shot speed item is turned off. The speed can be changed using the up/down buttons. Press button again to cancel settings.

	9		<p>This button can be selected in all modes.</p> <p>When you press this button, the green LED on the button is lit. Changeable items are displayed and values can be changed using the key pad in each mode.</p> <p>When you press Next button in the screen, you can set suck back time, suck back speed, compensation, etc.</p> <p>Once the setup is complete, pressing the button again will cancel the setup.</p>
	10		<p>CHANNEL can be selected in the time mode, steady mode and metering mode. When you press this button, the green LED on the button is lit. Channel can be changed using the up/down buttons.</p> <p>Press button again to cancel settings.</p>
Change Value	11		<p>Change the value at the setting screen of each item by using the up/down buttons, or by touching the input window and activating the 10 keypad that is displayed.</p> <p>Press the up button to increase the setting value.</p>
	12		<p>Change the value at the setting screen of each item by using the up/down buttons, or by touching the input window and activating the 10 keypad that is displayed.</p> <p>Press the down button to decrease the setting value.</p>

5.3 Time Mode Setting

You can set 1. Shot Time, 2. Shot Speed, 3. Suck Back Time, 4. Suck Speed, 5. Compensation by selecting the Setting button in time mode.

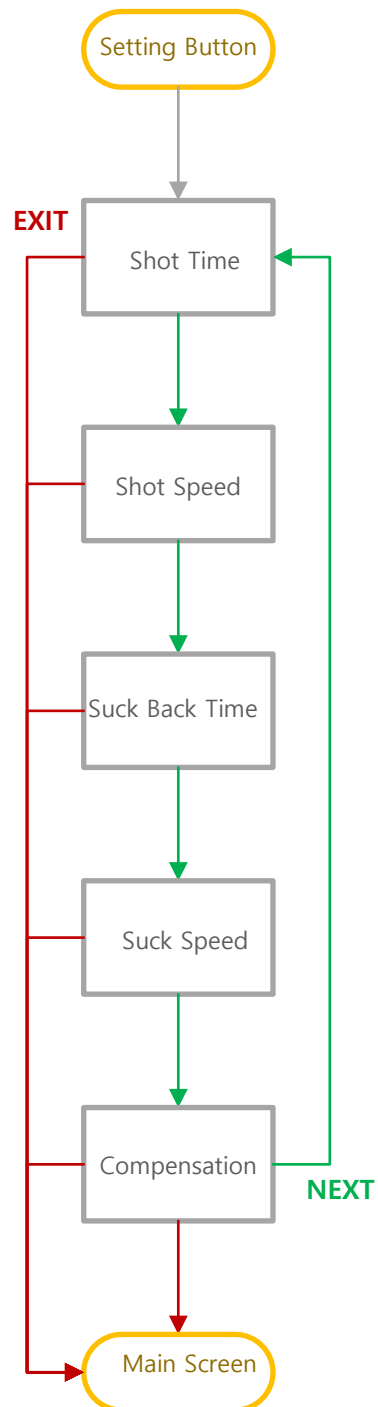

5.3.1 Shot Time Setting



Figure 9. Shot Time Setting Screen

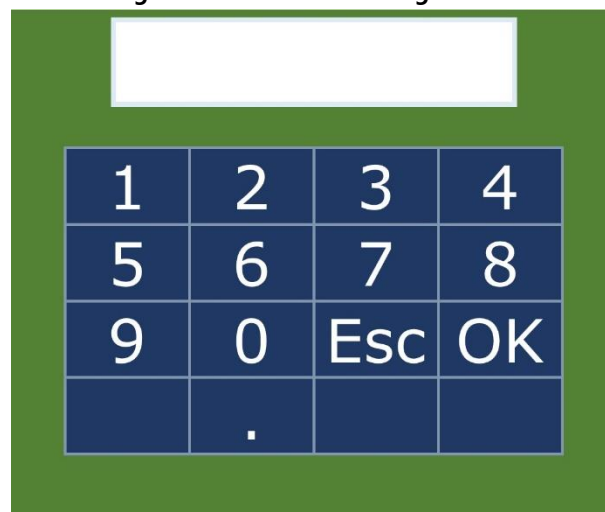

Figure 10. Key Pad Screen

- Set the shot time.
- The shot time setting sets the dispensing time. (0 ~ 9999.99 sec)
- By selecting the up/down key or data box, you can set the value through the keypad screen.
- If you want to go to the next setting menu, click 'Next' button.
- If you want to go to the main screen, click 'Exit' button.

5.3.2 Shot Speed Setting

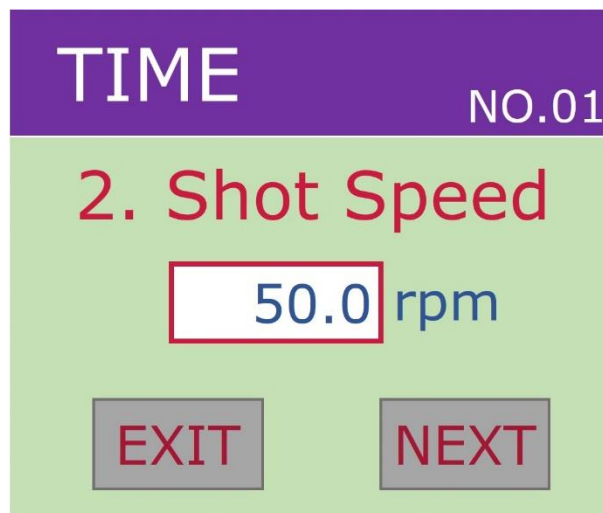

Figure 11. Shot Speed Setting Screen

- Adjust the speed of the pump.(0~9999.99sec)
- By selecting the up/down key or data box, you can set the value through the key pad screen.
- If you want to go to the next setting menu, click 'Next' button.
- If you want to go to the main screen, click 'Exit' button.

5.3.3 Suck Back Time Setting

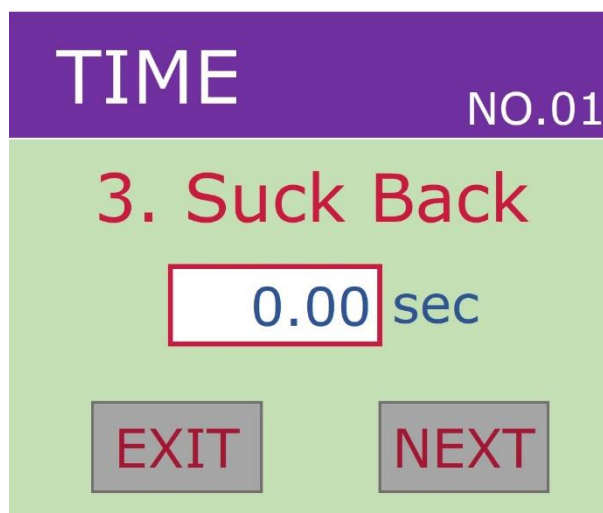

Figure 12. Suck-back Time Setting Screen

- Set the suction time for the solution. (0~9999.99sec)
- By selecting the up/down key or data box, you can set the value through the keypad screen.
- If you want to go to the next setting menu, click 'Next' button.
- If you want to go to the main screen, click 'Next' button.

5.3.4 Suck Back Speed Setting

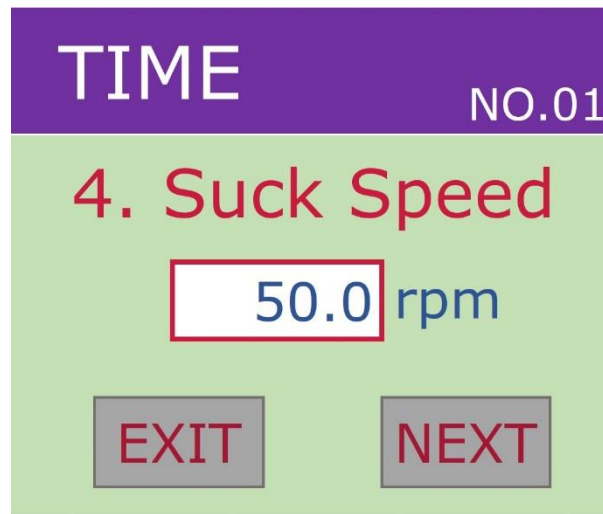

Figure 13. Suck Back Speed Setting

- Adjusts the suction pump's speed. (0~120rpm)
- By selecting the up/down key or data box, you can set the value through the key pad screen.
- If you want to go to the next setting menu, click 'Next' button.
- If you want to go to the main screen, click 'Exit' button.

5.3.5 Compensation Setting



Figure 14. Compensation Setting

- The setting range is 0 to 150%. The number of rotations increases or decreases according to the setting rate.
- The default value is 100% and works at a 1:1 ratio. Enter a value more than 100 to increase the number of rotations or less than 100 to decrease.
- By selecting the up/down key or data box, you can set the value through the key pad screen.
- If you adjust the value at random, the dispensing amount changes. Do not make changes except administrator.
- If you want to go to the next setting menu, click 'Next' button.
- If you want to go to the main screen, click 'Exit' button.



Caution

If compensation value is changed, the amount of shot is changed and not guaranteed to be quantified.

5.4 Steady Mode Setting

You can set 1. Shot Speed, 2. Suck Back Time, 3. Suck Back Speed, 4. Compensation by selecting the Setting button in steady mode.

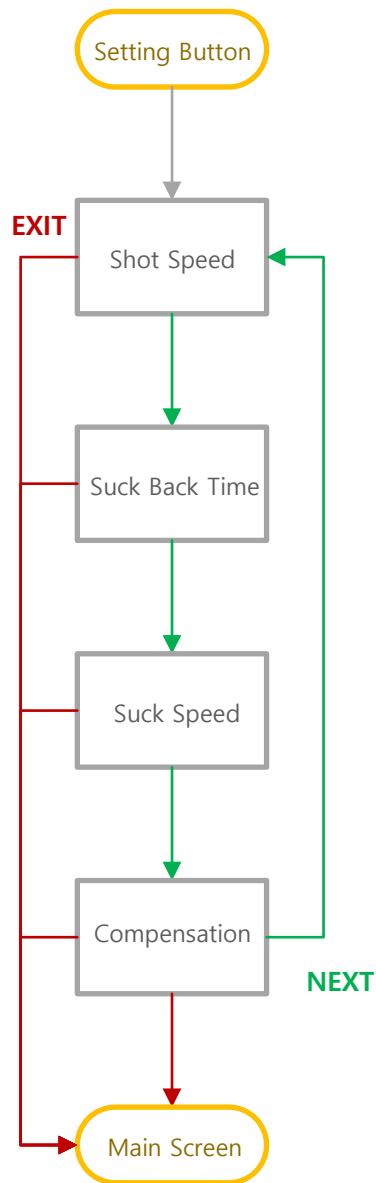

5.4.1 Shot Speed Setting

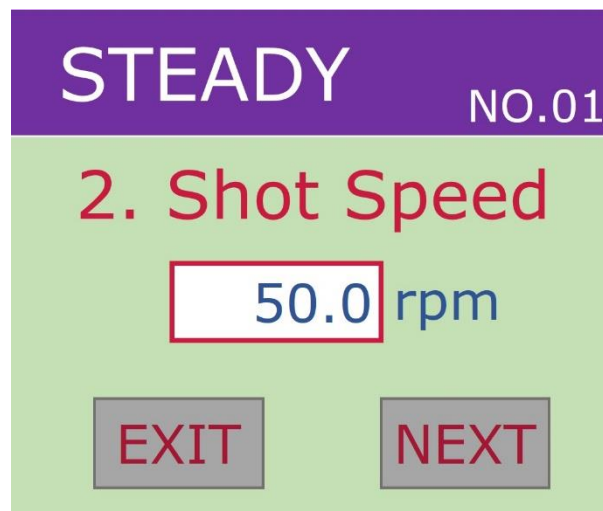

Figure 15. Shot Speed Setting

- Select the Setting button in steady mode to display the screen for shot speed.
- Adjusts the pump's speed.(0~120rpm)
- By selecting the Up/Down key or Data Box, you can set the value through the key pad screen.
- If you want to go to the next setting menu, click 'Next' button.
- If you want to go to the main screen, click 'Next' button.

5.4.2 Suck Back Time Setting

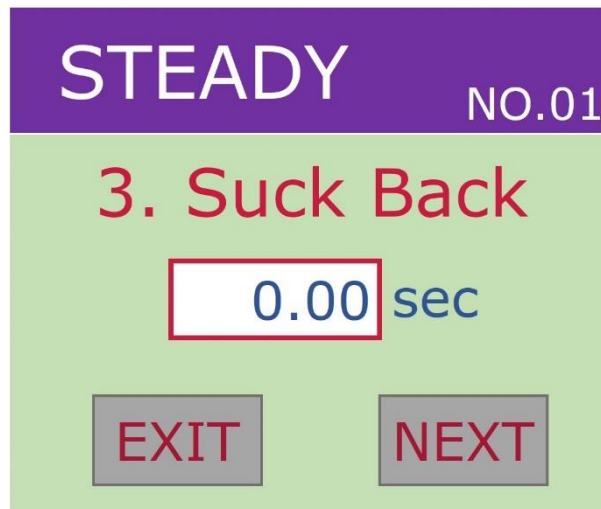

Figure 16. Suck Back Time Setting

- Select the Next button in the shot speed screen to display the screen for suck back time.
- Set the suction time for the solution. (0~9999.99sec)
- By selecting the Up/Down key or Data Box, you can set the value through the key pad screen.
- If you want to go to the next setting menu, click 'Next' button.
- If you want to go to the main screen, click 'Exit' button.

5.4.3 Suck Back Speed Setting

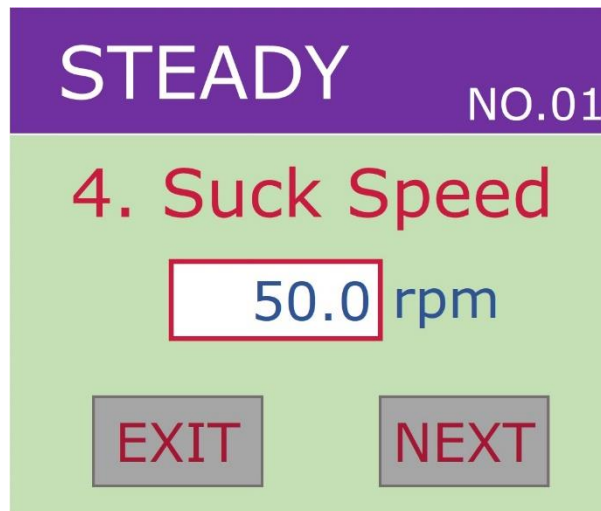

Figure 17.Suck-back Speed Setting

- Select the Next button in the suck back time screen to display the screen for suck back speed.
- Adjusts the suction pump's speed. (0~120rpm)
- By selecting the Up/Down key or Data Box, you can set the value through the key pad screen.
- If you want to go to the next setting menu, click 'Next' button.
- If you want to go to the main screen, click 'Exit' button.

5.4.4 Compensation Setting

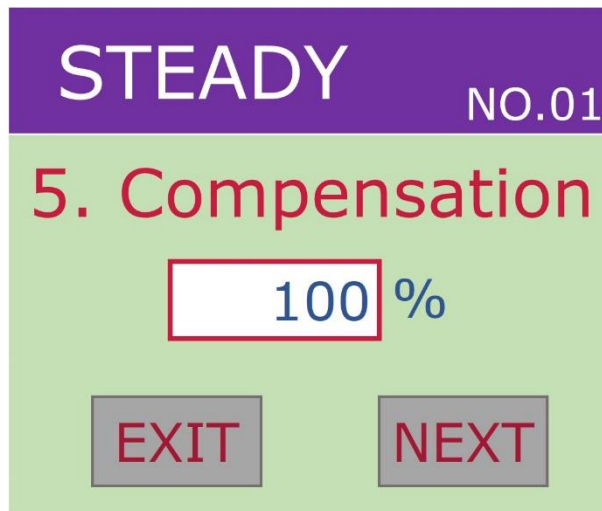

Figure 18. Compensation Setting

- Select the Next button in suck back speed screen to display the screen for compensation.
- Displays the ratio adjustment.(0~150%) The number of rotations increases or decreases according to the setting rate.
- The default value is 100% and works at a 1:1 ratio. Enter a value more than 100 to increase the number of rotations or less than 100 to decrease.
- By selecting the Up/Down key or Data Box, you can set the value through the key pad screen.
- If you adjust the value at random, the dispensing amount changes. Do not make changes except administrator.
- If you want to go to the next setting menu, click 'Next' button.
- If you want to go to the main screen, click 'Exit' button.



Caution

If compensation value is changed, the amount of shot is changed and not guaranteed to be quantified.

5.5 Metering Mode Setting

You can set 1. Volume, 2. Shot Speed, 3. Suck Back(Time), 4. Suck Speed, 5.Compensation by selecting the Setting Button in metering mode.

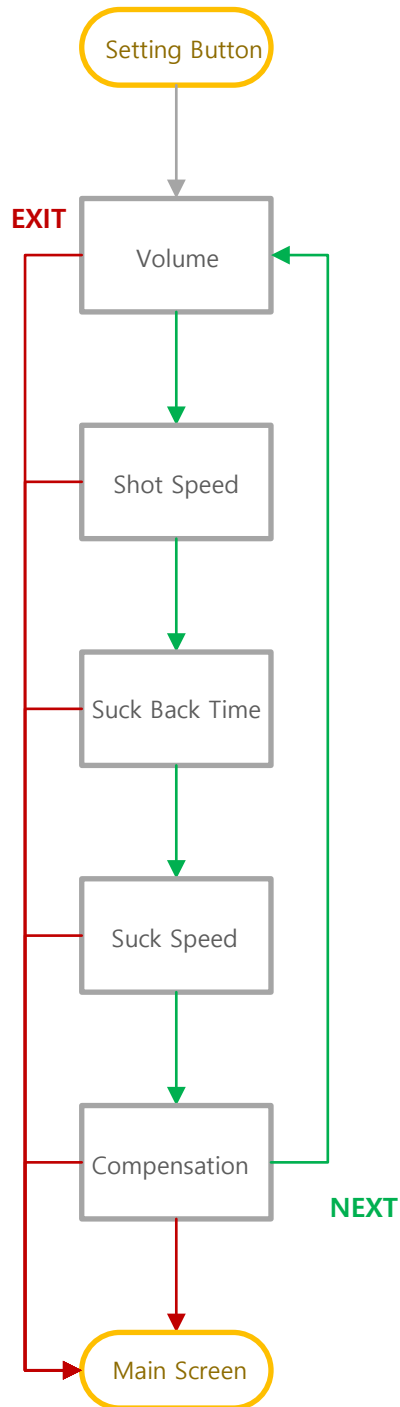

5.5.1 Volume Setting

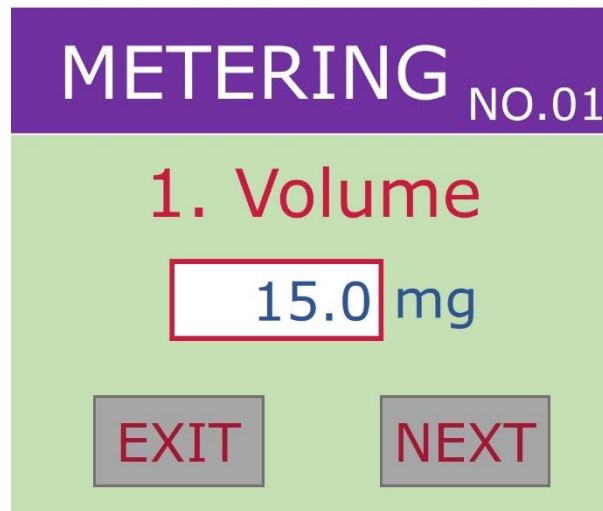

Figure 19. Volume Setting

- Select the Setting button in metering mode to display the screen for setting the volume.
- The setting range is 0 to 3000ml.
- By selecting the Up/Down key or Data Box, you can set the value through the key pad screen.
- If you want to go to the next setting menu, click 'Next' button.
- If you want to go to the main screen, click 'Exit' button.

5.5.2 Shot Speed Setting

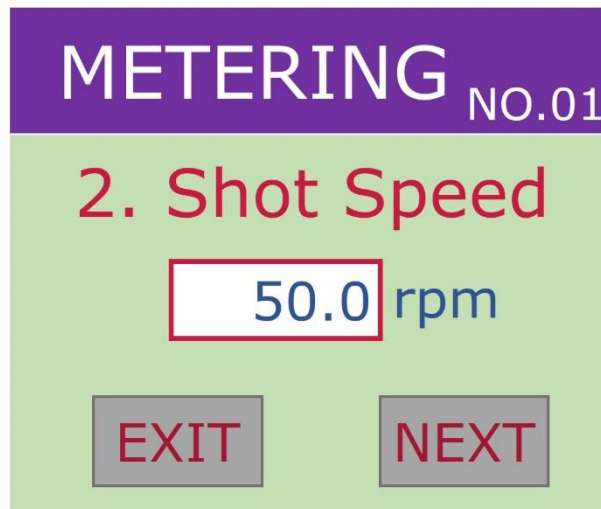

Figure 20. Shot Speed Setting

- Select the Next button in volume screen to display the screen for setting the shot speed.
- The setting range is 1 to 120 rpm.
- By selecting the Up/Down key or Data Box, you can set the value through the key pad screen.
- If you want to go to the next setting menu, click 'Next' button.
- If you want to go to the main screen, click 'Exit' button.

5.5.3 Suck Back Time Setting

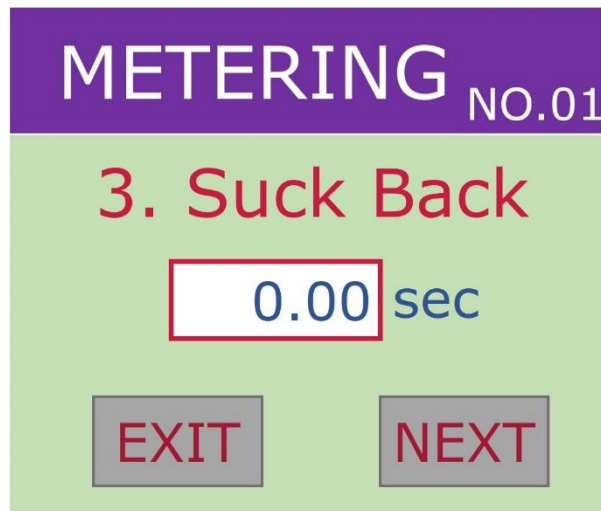

Figure 21. Suck-back Time Setting

- Select the Next button in shot speed screen to display the screen for setting the suck back time.
- The setting range is 0 to 9999.99sec.
- By selecting the Up/Down key or Data Box, you can set the value through the key pad screen.
- If you want to go to the next setting menu, click 'Next' button.
- If you want to go to the main screen, click 'Exit' button.

5.5.4 Suck Back Speed Setting

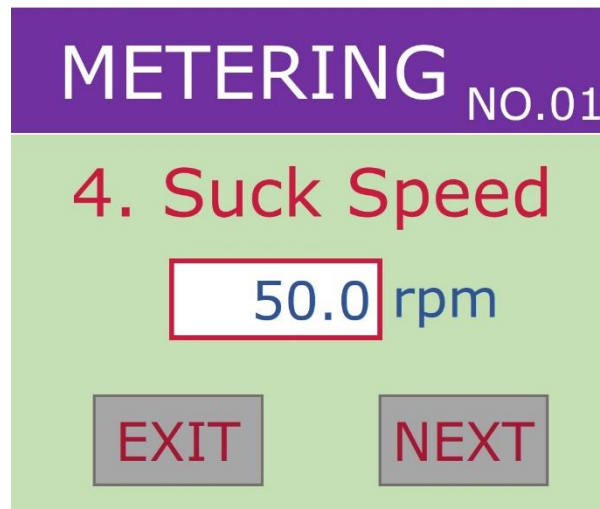

Figure 22.Suck-back Speed Setting

- Select the Next button in suck back time setting screen to display the screen for setting the suck back speed.
- The setting range is 1 to 120rpm.
- By selecting the Up/Down key or Data Box, you can set the value through the key pad screen.
- If you want to go to the next setting menu, click 'Next' button.
- If you want to go to the main screen, click 'Exit' button.

5.5.5 Compensation Setting

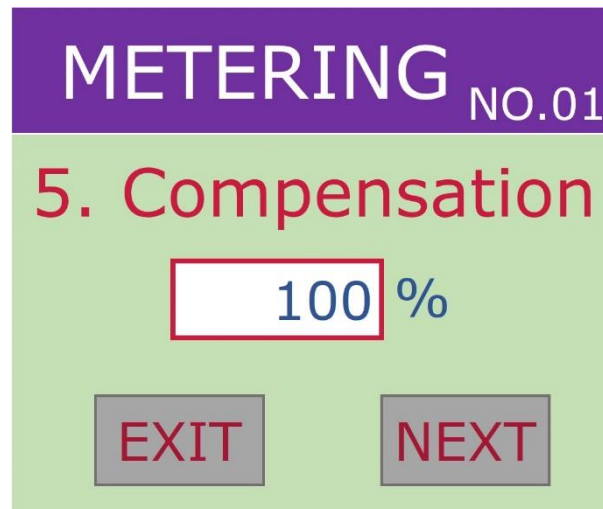

Figure 23. Compensation Setting

- Select the Next button in suck back speed screen to display the screen for the compensation.
- Displays the ratio adjustment.(0~150%) The number of rotations increases or decreases according to the setting rate.
- The default value is 100% and works at a 1:1 ratio. Enter a value more than 100 to increase the number of rotations or less than 100 to decrease.
- By selecting the Up/Down key or Data Box, you can set the value through the key pad screen.
- If you adjust the value at random, the dispensing amount changes. Do not make changes except administrator.
- If you want to go to the next setting menu, click 'Next' button.
- If you want to go to the main screen, click 'Exit' button.



Caution

If compensation value is changed, the amount of shot is changed and not guaranteed to be quantified.

5.5.6 Purge Time Setting

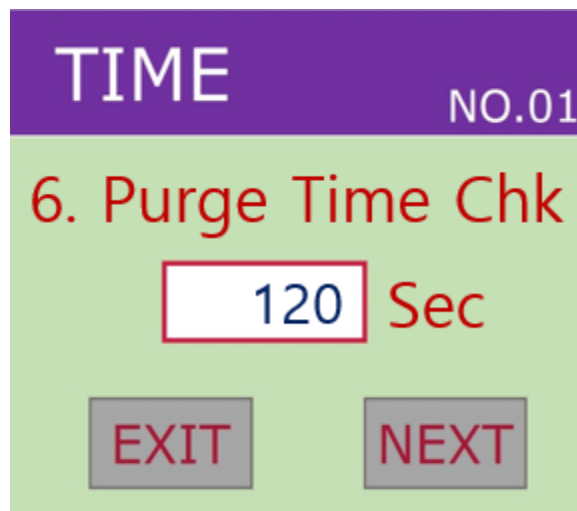

- Touch the NEXT button on the Compensation ratio setting screen to display the screen where you can set the Purge Time as shown above.
- The setting range can be set from 0 to 9999 sec, and a Purge Time Error will occur if the set time has passed since the SHOT operation. When set to 0, "OFF" is displayed.
- By selecting the up/down key or data box, you can set the value through the key pad screen.
- If you want to go to the next setting menu, click 'Next' button. You will be returned to the initial setting screen and the setting screen will circulate.
- If you want to go to the main screen, click 'Exit' button.

5.6 System Set

Set the Calibration, Pressure, System I/O Check, Parameter Setting, etc. other than the default settings for dispensing in "SYSTEM SET".

Press and hold the Setting button(9) on the front of the Procon-100 for approximately 2 seconds to access the System Setting menu.

Each item in SYSTEM SET can be changed to the touch screen and the Setting button will return to the main screen.

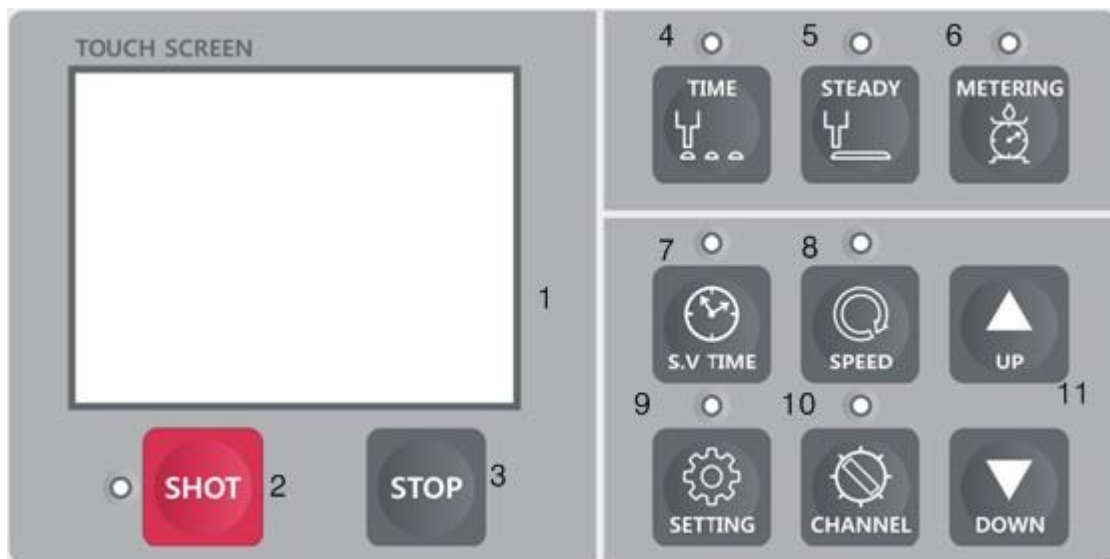

Figure 24. Controller Button

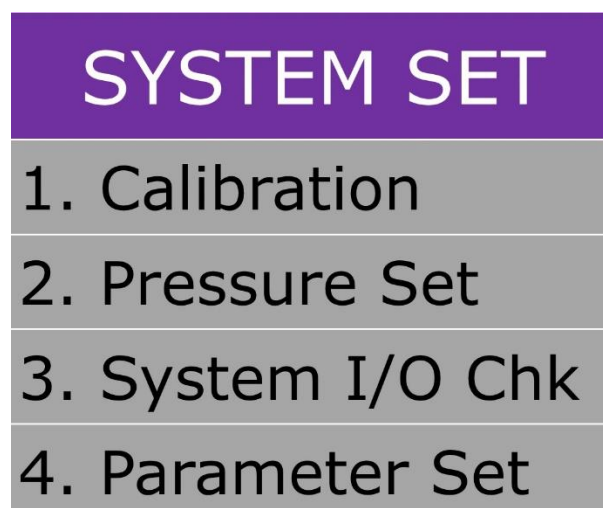

Figure 25. System Setting Screen

5.6.1 Calibration



The Pro-Pump we manufacture and sell are volumetric pump. So additional work is required for a fixed quantity(weight). Procon-100 provides Calibration function for the fixed quantity dispensing. Calibration function is used to correct the density of the material and error in the product to ensure a quantitative dispensing.

The output quantity of Procon-100 is set to the theoretical output of each model, and the formula for the program is based on this.

Table 8. Pro-Pump Dosing Volume

Model	Dosing Volume(ml/rev)
PCP-005	0.005
PCP-015	0.015
PCP-050	0.05
PCP-150	0.15
PCP-500	0.5
PCP-1000	1

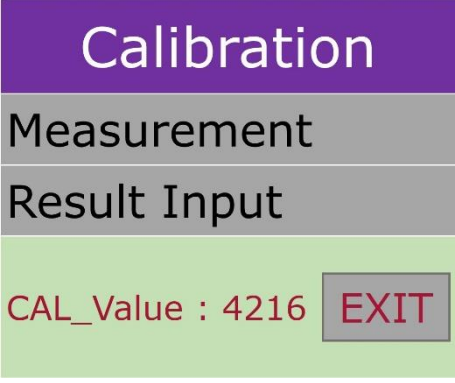
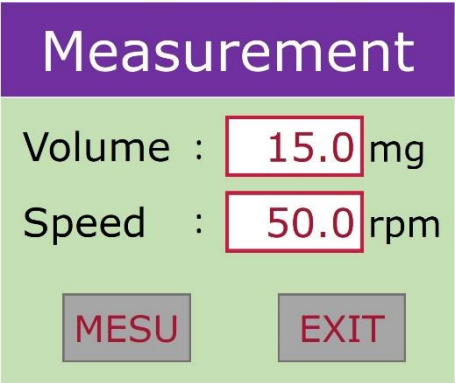
Table 9. Calibration Setting

Display	Function and Description
	<ul style="list-style-type: none"> * Measurement : Using this button, you can move to 'Measurement Menu'. * Result Input : Using this button, you can move to 'Measurement Value Input Menu'. * EXIT : Select this when moving to the previous screen.
	<ul style="list-style-type: none"> * Volume : Enter the dispensing volume which you want to measure. * Speed : Sets the dispensing speed. * MESU : Select this when dispensing is completed after setting the dispensing condition. * EXIT : Select this when moving to the previous screen. * To calculate the measurement value, repeat several times and input the average value.(About 10 times recommended)
	<ul style="list-style-type: none"> * After making measurements in the Measurement Menu, input the results and save them. * After this, the measured volume is automatically compensated based on this value..

5.6.2 Pressure Set

If a pressure sensor is attached, the pressure value can be set to detect material curing and nozzle blockages. Attaching the pressure sensor is optional.

Table 10. Pressure Setting



Names and Displays	Function and Description
<div style="background-color: #4a4a9a; color: white; padding: 5px; text-align: center; font-weight: bold;">Pressure SET</div> <div style="background-color: #d4e1d4; padding: 10px; text-align: center;"> <p style="color: #c00000; font-weight: bold;">Using Set</p> <div style="border: 1px solid #c00000; display: inline-block; padding: 5px 15px; margin: 5px;">OFF</div> <div style="display: flex; justify-content: space-around; margin-top: 10px;"> <div style="background-color: #cccccc; padding: 5px 10px; border: 1px solid #ccc;">EXIT</div> <div style="background-color: #cccccc; padding: 5px 10px; border: 1px solid #ccc;">NEXT</div> </div> </div>	<ul style="list-style-type: none"> * You can set the pressure value according to the solution used and set the alarm to sound when the pressure lower or high. * You can set ON/OFF by touching Data Box.
<div style="background-color: #4a4a9a; color: white; padding: 5px; text-align: center; font-weight: bold;">Pressure SET</div> <div style="background-color: #d4e1d4; padding: 10px; text-align: center;"> <p style="color: #c00000; font-weight: bold;">Desire Press</p> <div style="border: 1px solid #c00000; display: inline-block; padding: 5px 15px; margin: 5px;">300</div> kPa <div style="display: flex; justify-content: space-around; margin-top: 10px;"> <div style="background-color: #cccccc; padding: 5px 10px; border: 1px solid #ccc;">EXIT</div> <div style="background-color: #cccccc; padding: 5px 10px; border: 1px solid #ccc;">NEXT</div> </div> </div>	<ul style="list-style-type: none"> * You can set the dispensing pressure according to the material used. * You can set the pressure value by touching Data Box.
<div style="background-color: #4a4a9a; color: white; padding: 5px; text-align: center; font-weight: bold;">Pressure SET</div> <div style="background-color: #d4e1d4; padding: 10px; text-align: center;"> <p style="color: #c00000; font-weight: bold;">Tolerance</p> <div style="border: 1px solid #c00000; display: inline-block; padding: 5px 15px; margin: 5px;">10</div> % <div style="display: flex; justify-content: space-around; margin-top: 10px;"> <div style="background-color: #cccccc; padding: 5px 10px; border: 1px solid #ccc;">EXIT</div> <div style="background-color: #cccccc; padding: 5px 10px; border: 1px solid #ccc;">NEXT</div> </div> </div>	<ul style="list-style-type: none"> * You can set the tolerance of the dispensing pressure value. * You can set the tolerance by touching Data box.

<p>Pressure SET</p> <p>Sensor Using</p> <p>OFF</p> <p>EXIT NEXT</p>	<ul style="list-style-type: none"> * Set whether to use the pressure sensor. * You can set ON/OFF by touching Data Box.
<p>Pressure SET</p> <p>Sensor Desire</p> <p>1000 kPa</p> <p>EXIT NEXT</p>	<ul style="list-style-type: none"> * You can set the sensor's dispensing pressure according to the material used. * You can set the pressure value by touching Data Box.
<p>Pressure SET</p> <p>Sensor Tolerance</p> <p>10 %</p> <p>EXIT NEXT</p>	<ul style="list-style-type: none"> * You can set the tolerance of the pressure sensor's pressure value. * You can set the tolerance by touching Data box.

5.6.3 System I/O Check

I/O Check is to check if the controller is operating properly.

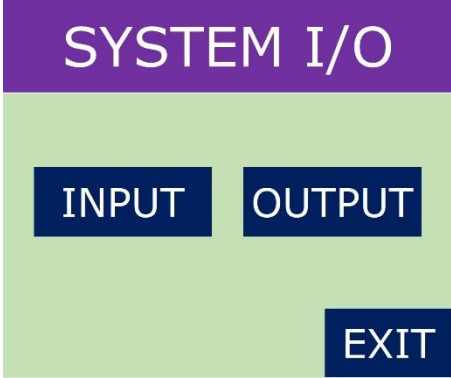
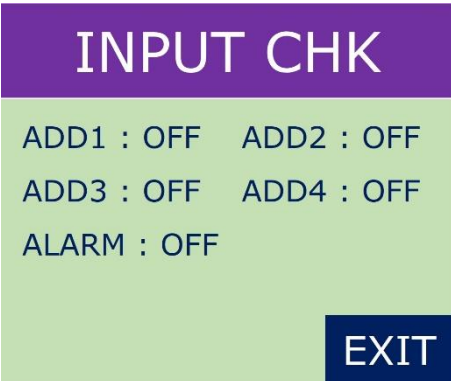
Table 11. System I/O Check

Names and Displays	Function and Description
	<ul style="list-style-type: none"> * Select Input(Input port) or Output(Output port) according to the port to be set. * If you want to move to the previous screen, select the 'Exit' button.
	<ul style="list-style-type: none"> * If the external input signal(controller's rear input port) is present, it is on. Otherwise, it is off * If you want to move to the previous screen, select the 'Exit' button.
	<ul style="list-style-type: none"> * You can forcibly turn On/Off the external output signal. <ul style="list-style-type: none"> ■ Ready : On when dispensing is possible ■ Shot : On during dispensing ■ M_ALR : On when motor or encoder is error ■ P_ALR : On when above setting pressure ■ S_END : On when dispensing is completed in time mode * If you want to move to the previous screen, select the 'Exit' button.

5.6.4 Parameter Setting

Set defaults for the Pro-Pump model to be applied.

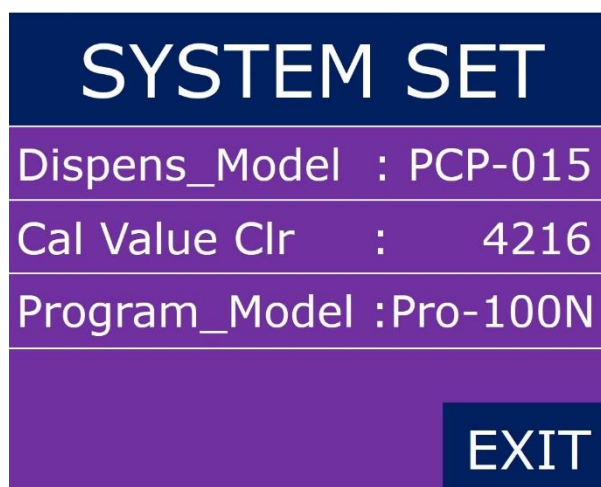

Figure 26. Parameter Setting Screen

Table 12. Parameter Setting

Name and Display	Function and Descriptions
<p>Dispens_Model : PCP-015</p>	<ul style="list-style-type: none"> * Select the model of dispenser. <ul style="list-style-type: none"> - PCP-005 - PCP-015 - PCP-050 - PCP-150 - PCP-500 - PCP-1000
<p>Cal Value Clr : 4216</p>	<ul style="list-style-type: none"> * Set the calibrated value. * Cal Value is different depend on Pro Pump model. * If cal value is changed, the amount of shot is changed and not guaranteed to be quantified.
<p>Program_Model : Pro-100N</p>	<ul style="list-style-type: none"> * Displays the model name of the controller in use.

5.7 Lock Function Setting

5.7.1 Check Point before set-up the Lock Function



Figure 27. Start-Up Screen

- Please check the controller's version "2.71N" after turn on the power.



Figure 28. Main Screen

- You can see the main screen after checking the "Start-Up Screen".

5.7.2 How to set-up the lock function

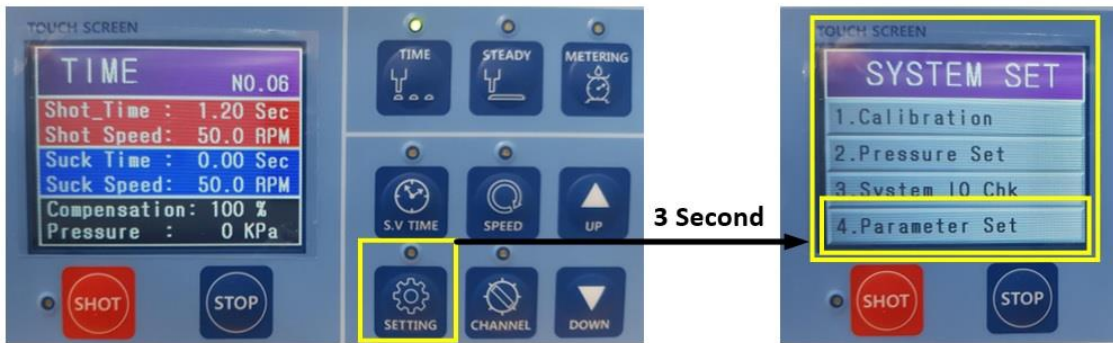

Figure 29.

- Please press the "SETTING" button for 3 seconds, then you can move the "SYSTEM SET" screen.



Figure 30.

- After Moving "4. Parameter Set" you can press the button "PASSWORD" for setting-up the new password then press "OK" button. (If you want to change the password, you can also follow up same as setting process.)

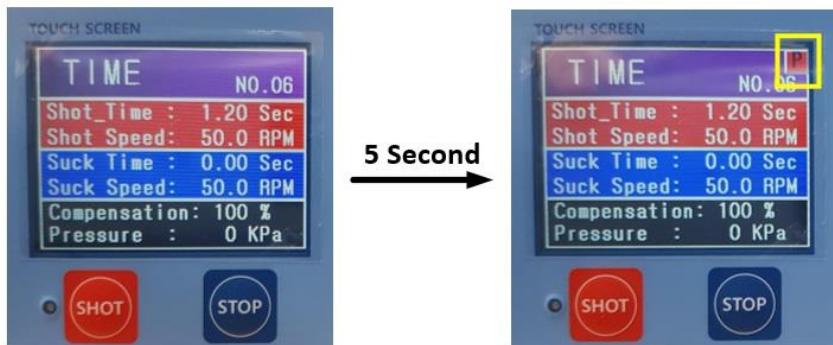

Figure 31.

- You can see the "P" mark after passing 5 seconds, after return to "MAIN SCREEN".

5.7.3 How to operate during locking



Figure 32.

- If you want to activate some buttons which are marked with yellow box, you should input a password. (In case of turn on LED on the button, there is no need to input the password.)



Figure 33



Figure 34

- If there is no activity for 5 seconds, after return to main screen, the display should be locked automatically.

5.7.4 How to Unlock

There are two kinds of unlocking.

- 1) Standard Unlock Process
- 2) Exceptional unlock process, if you forget the password.

Table 13. Standard Unlock Process

Standard Unlock Process

Please press button "Setting" for 3 seconds, if you want to unlock.

Please press the button "Parameter Set" on "System Set" display, then please input the password "0".The lock function could be removed.

Table 14. Exceptional unlock process, if you forget the password.

Exceptional unlock process, if you forget the password

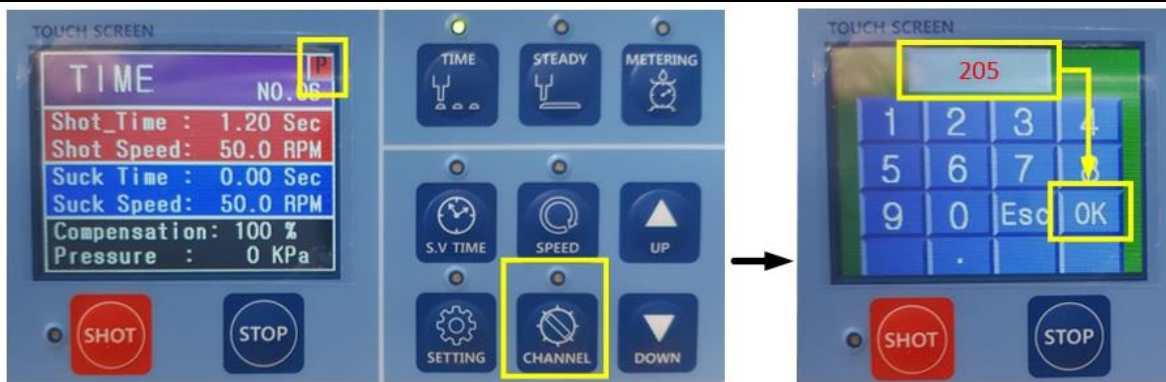

Please press the button "Channel" then input the special password "205".



You can see the yellow light above "Channel" button

5.8 Pressure sensor for PROCON-100 (option)

5.8.1 Connection guide

When using an external pressure sensor, modify the circuit inside the existing controller and connect the pressure sensor cable to the rear terminal.(option)

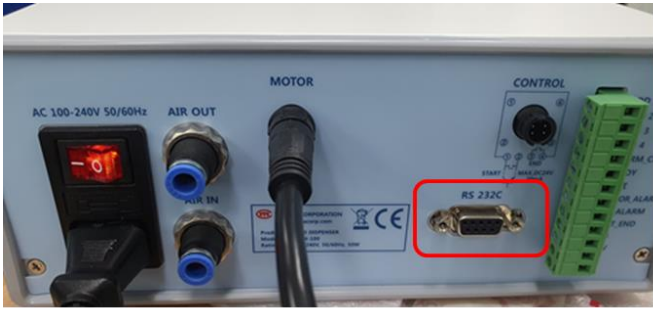

< std controller >



< pressure sensor optional controller

>

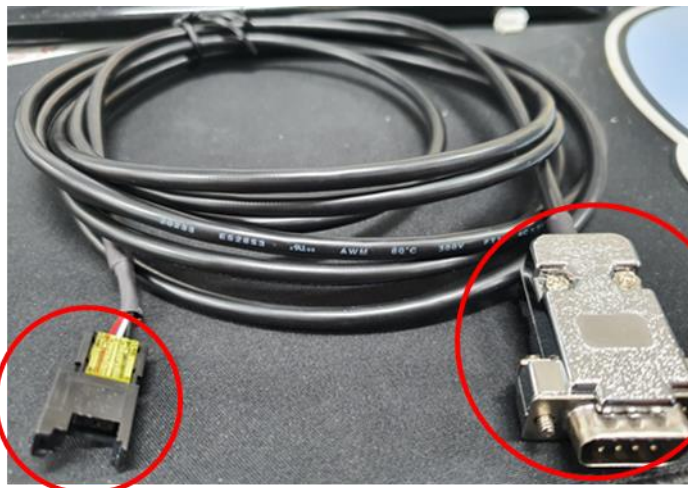

The cable is as above.

5.8.2 How to set up the pressure sensor function on controller

1) After turning on the power, set using the front display and buttons.



< Before setting >



< Pressure set >



< Over pressure setting >



< After setting >

2) After setting, you can check the pressure value on display.

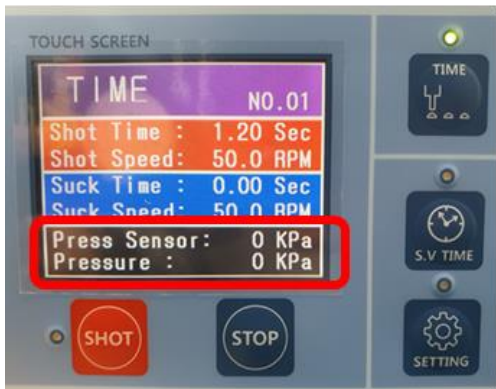

< Happen alarm >

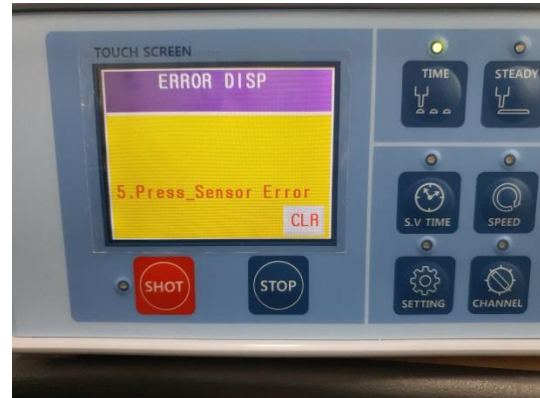

< Alarm >

Pressure relief

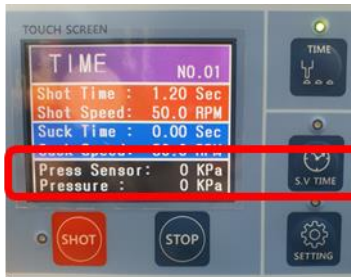

Maintaining function



CLR



Cancel

5.8.3 I/O communication for pressure transducer

When the pressure sensor make an alarm, you can get the signal by 'PRE_ALARM' connection

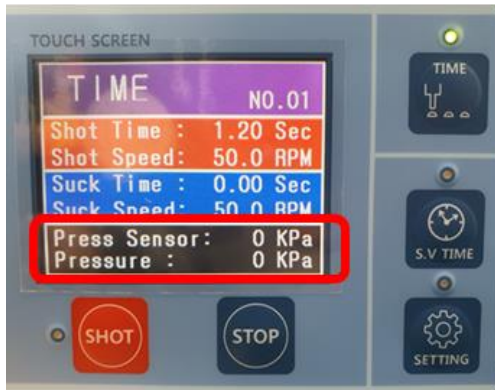

< Alarm >



< Error display >



< Back side >

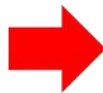

Signal to get the pressure sensor by PRE-ALARM.

6 Controller Internal Configuration

Controller Internal Configuration

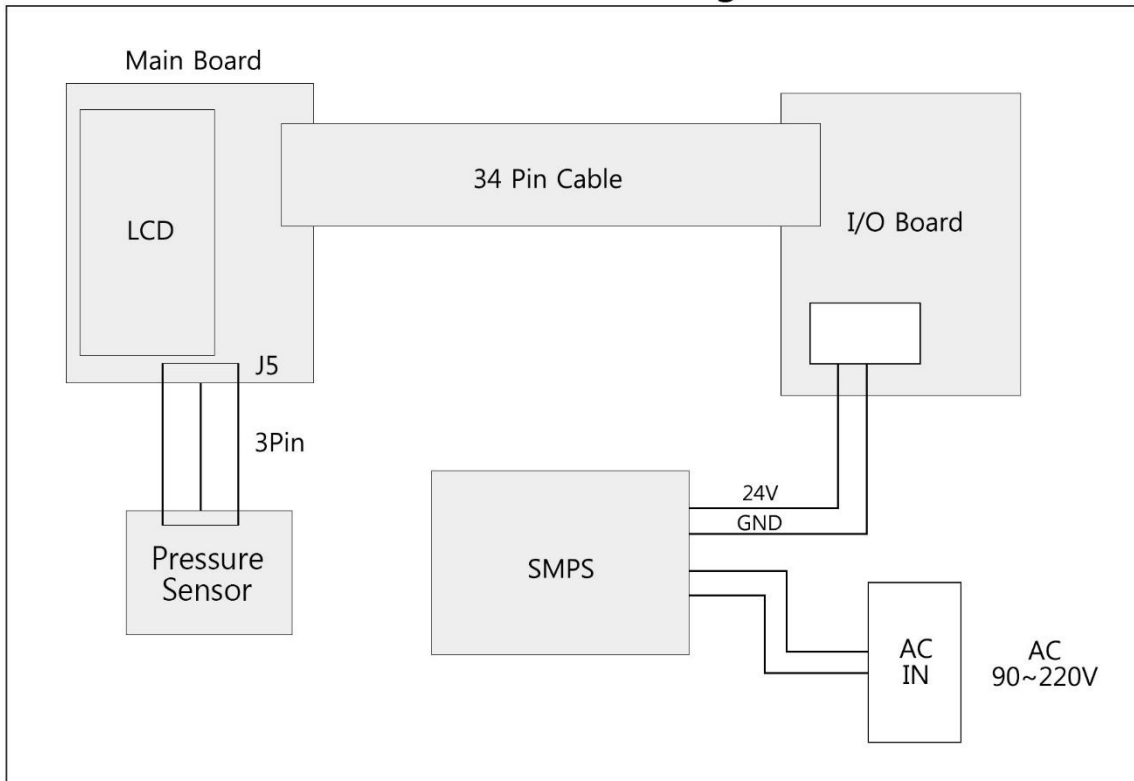

7 Maintenance

This equipment is composed of robot part responsible for motion operation, dispenser responsible for dispensing and dispenser controller, so regular inspections are required.

In order to prevent malfunctions caused by various factors, please perform occasional(user-determined) and periodic(within a year) inspections.



Danger

Be sure to take necessary measures such as manual mode of the equipment, emergency stop, power off, etc. before performing maintenance and inspection. If the power is not turned off, any material inside the equipment or the inspector may be detected by the sensor, which may occur movement of the equipment. It may also cause electric shock.



Caution

Some alarms cannot be released even after reset. In this case, you must reboot (power on/off) after completing action for the relevant error.

7.1 Part Replacement

As the functional use time of parts becomes long, aging may occur and it may cause the failure of the equipment. Check regularly for trouble prevention of the equipment, and, in case of abnormality, replace parts.

7.2 Trouble Shooting

Table 15. Procon-100 Trouble Shooting

Trouble	Possible Cause & Correction
If the dispensing is not possible	<ol style="list-style-type: none"> 1) Check the air supply in the tank. 2) Check the controller power supply. 3) Check whether the solution is there. 4) Check if the solution is loaded in the conduit line. 5) Check the connection of the air fitting. 6) Check the connection of the air fitting in the conduit line of solution. 7) Check whether the nozzle is clogged. 8) Check whether the pump motor is operating.
If there is a change in the dispensing volume	<ol style="list-style-type: none"> 1) Check if there is any change in the setting value of the controller. 2) Check if there is any solidification of the solution in the chamber. 3) Check if there is any clogging in the needle. 4) Check if there is any air bubble in the conduit line and chamber. 5) Check if there is a change in the tank air supply pressure. 6) Check if there is a leak in the liquid connection fitting.
If there is a leak in nozzle end during the standby time after dispensing	<ol style="list-style-type: none"> 1) Check if there is an abrasion in the rubber part of stator. 2) Check if the tank air pressure has been set high. (The pressure setting for the tank air must be set to the extent that the fluid is transported to the pump chamber.) 3) Check if there is continuous operation of the pump drive motor.
If the pump drive motor does not operate	<ol style="list-style-type: none"> 1) Check the connection of the motor cable. 2) Check the set value of the controller. 3) Check the power supply status. 4) Check if the solution is solidified in the pump chamber.
If the solution leaks out of the pump	<ol style="list-style-type: none"> 1) Check if o-ring between chamber and seal block has been damaged. 2) Check the status of abrasion of the rotary seal in the seal block.
If an abnormal noise occurs while the pump is operating	<ol style="list-style-type: none"> 1) Check if the bearing in the bearing block has been damaged. 2) Check the status of abrasion of the rotary seal in the seal block. 3) Check the condition of the motor reducer.

7.3 Inspection and Measures

Table 16. Inspection and measures for Procon-100

Inspection	Inspection Cycle	What to check and what to do	Remarks
Ambient Environment	Occasionally	Confirm that it meets the usage standards of the equipment.	
Power Supply Voltage	Occasionally	Check if the power is AC220V and 50/60Hz.	
Appearance of Equipment	Periodically	Check if the connection parts(connector, terminal block, etc.) are loose and tightly fasten the loose parts.	
Cables	Periodically	Check if the cover is peeled or there is severe bending.	
Internal State of Equipment	Periodically	Keep it clean to prevent so that the contamination by dust or solution does not interfere with the operation of the equipment.	
Supplied Air	Occasionally	Check the piping connection, joint, or if there is no leakage so that the supplied air maintains normal pressure.	
Other Checks	Periodically	<ul style="list-style-type: none"> - Fastening condition of the fixed parts and joints in the equipment - Joined and tightened condition of wiring - Arrangement condition around the equipment. 	